

Fermvision 2 Wire Residential Quick Guide

Access codes Keypad door station..... 2

 Adding a code: 2

 Editing codes:..... 2

 Reset codes: 2

 Changing Master code: 2

Accessing to programming menu – Monitors..... 2

Programming Monitor address (When using more than one monitor): 3

Unlock Time 4

 Programming from monitor:..... 4

 Programming from door station (Keypad only):..... 4

Programming Door Station address (When using more than one door station) 5

 a. Keypad Door Stations..... 5

 b. Proximity Door Stations: 5

 c. No access control Door Station:..... 5

Extras..... 5

 Monitor button light: 5

Electric Lock connection..... 6

Access codes Keypad door station

Adding a code: Input master code (1234 by default) and press #, then choose an address (starts from 20 up to 59) and press #, input an access code (up to 12 digits) and press #, finally press * to exit. Input new code and press # to unlock the door. *(It is recommended to keep a list of users/address for future reference)*

E.G:

Input code 5029 into location 20: 1234#, 20#, 5029#, *

Input code 2458 into location 21: 1234#, 21#, 2458#, *

Editing codes: overwrite the previous one by selecting the same position.

E.G:

Replacing code for 2458 in location 20: 1234#, 20#, 2458#, *

Changing Master code: Input previous master code (1234 by default) and press #, 01#, input new master code and press #.

E.G:

Changing master code to 3461: 1234#,01#,3461#.

Reset all codes: Input master code (1234 by default) and press #, 06# then input 1234 and press #, finally press *. *(It will cancel all the access codes, and the master code will restore to 1234.)*

*This steps have to be done in a short time (no more than 3 seconds between steps) or else the door station will time out, if this happens press * to cancel and start over again*

Accessing to programming menu - Monitors

Turn on monitor, press the FERMVISION logo located at the bottom left of the screen (Figure 1), and then hold down the key button (right hand side of the main button) (Figure 2) until a new menu comes up, which is shown on Figure 3.



Figure 1

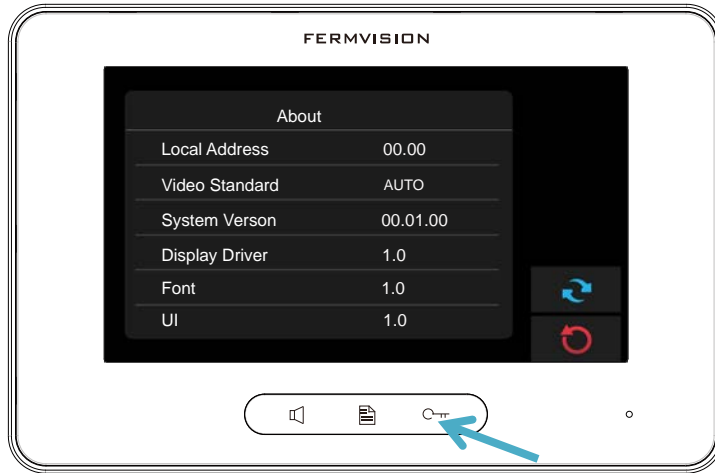

Figure 2



Figure 3

Programing Monitor address (When using more than one monitor):

Use Table below for Dip switch Addressing.



Master – Addressed as 0





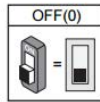
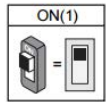



























For slave monitor 1 Addressed as 1: 8006, OK

For slave monitor 2 Addressed as 2: 8006, OK

Bit-6 line terminal setting:



Bit state	Setting	Bit state	Setting
	Monitor not at the end of the line.		Monitor at the end of the line.

Bit state	Address	Bit state	Address	Bit state	Address
	Code=1		Code=12		Code=23
	Code=2		Code=13		Code=24
	Code=3		Code=14		Code=25
	Code=4		Code=15		Code=26
	Code=5		Code=16		Code=27
	Code=6		Code=17		Code=28
	Code=7		Code=18		Code=29
	Code=8		Code=19		Code=30
	Code=9		Code=20		Code=31
	Code=10		Code=21		Code=32
	Code=11		Code=22		

Unlock Time

Programming from monitor: Access to programming menu (see above) and then input code 84XX (where XX goes from 01 to 99 seconds), finally press OK to confirm.

E.G:

For a door opening time of 8 seconds: input code 8408 and press the button OK

Programming from door station (Keypad only): Input master code (1234 by default) and press #, 03#, XX# (where XX goes from 01-99 seconds), then *. *(it must be 2 digits).*

E.G:

For a door opening time of 7 seconds: press 1234#, 03#, 07#, *

For a door opening time of 11 seconds: press 1234#, 03#, 11#, *

Programming Door Station address (When using more than one door station)

- a. **Keypad Door Stations:** Set an address by using the following sequence of codes: Input master code (1234 by default) and press #, 14#, X# (where X goes from 0-3), *.

E.G:

For Keypad door station 1: 1234#, 14#, 0#, *.

For Keypad door station 2: 1234#, 14#, 1#, *.

- b. **Proximity Door Stations:** Press and hold call button for 3 seconds and then let go, press and hold call button for 3 seconds again and let go, notice the address set up by the colour of the light out of the door station (ID0:cyan, ID1:green, ID2:yellow, ID3:red)
Press the call button to switch between the different address numbers / colours, press and hold the call button for 3 seconds again to save the settings.

E.G:

Setting door station address as 2: Press and hold call button for 3 seconds, let go, press and hold call button for 3 seconds, let go, press call button once (do not hold), colour will change to green, press and hold call button again for 3 seconds to save, colour will change back to blue (idle).

Setting door station address as 4: Press and hold call button for 3 seconds, let go, press and hold call button for 3 seconds, let go, press call button three times (do not hold), colour will change until it gets to red, press and hold call button again for 3 seconds to save, colour will change back to blue (idle).

- c. **No access control Door Station:**

Press KEY_SET button, then press KEY_X once (where X goes from 1-4), wait 10 seconds or press KEY_SET button four times to save the settings.

E.G.:

For door station 1: KEY-SET, KEY_1, press KEY_SET four times.

For door station 2: KEY-SET, KEY_2, press KEY_SET four times.

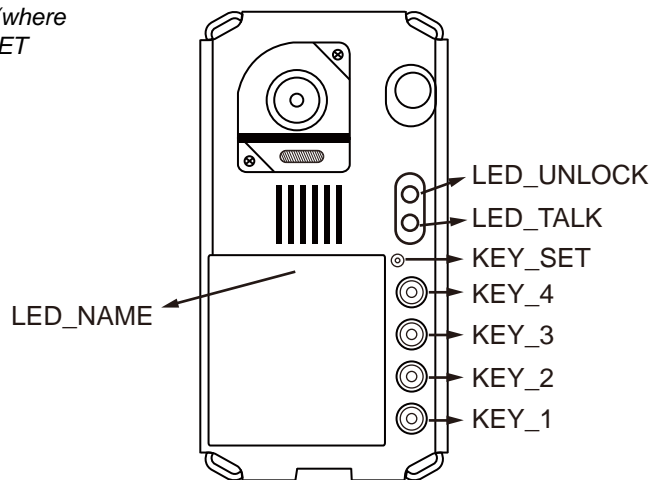

Figure 4

Extras

Monitor button light:

Access to programming menu (**section 3**) and input one of the following codes followed by OK button.

Turn the Green Light off - 8057

Turn the Green Light on - 8052

Electric Lock connection

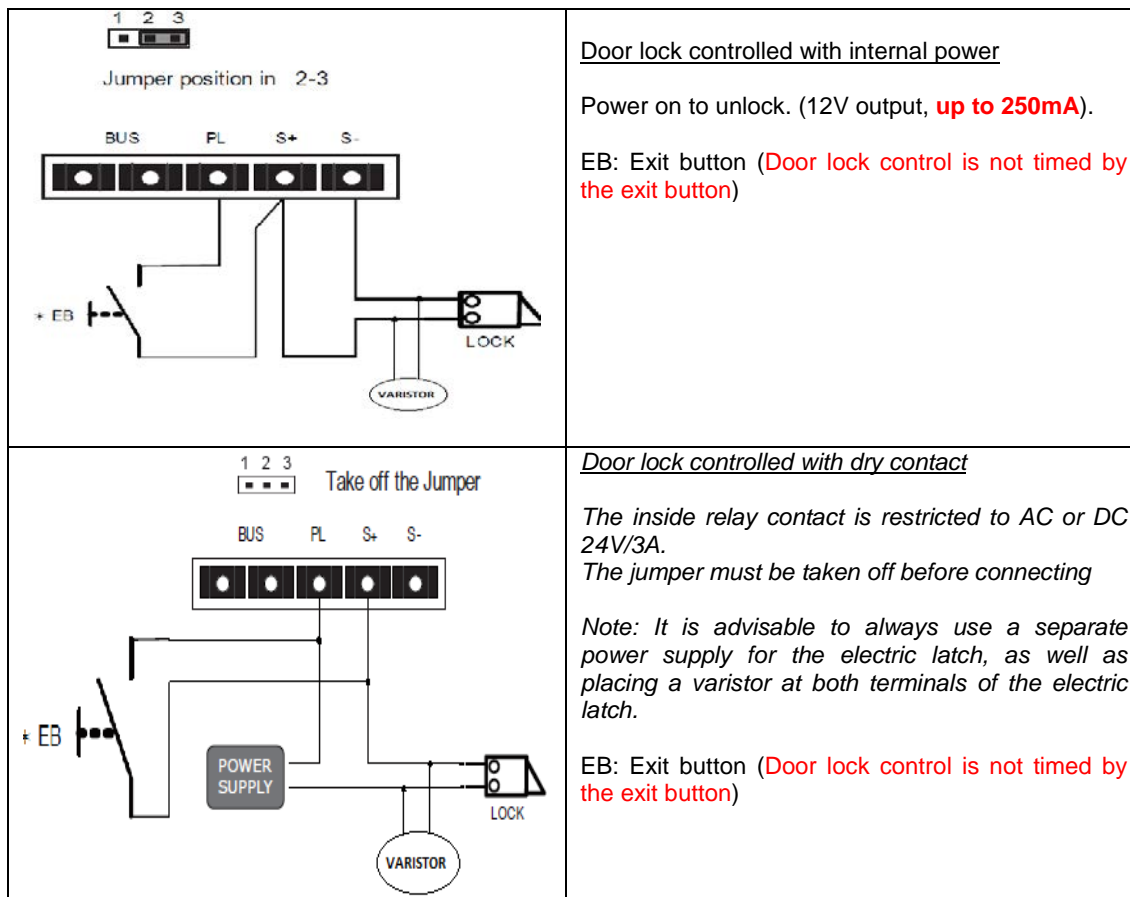

NOTE: Remove protective plastic film out of monitors and door stations, before using them.

For more details about the Fermvision system, follow the instructions on the manual included with each product or visit our website www.fermaxaus.com.au