



Two-wire

Villa Intercom System

User Manual



Content

1. System Functions.....	1
2. Components.....	1
3. Product Discription.....	2
Door Station.....	2
Indoor Phone.....	2
4. System Diagram.....	3
5. Wiring Diagram.....	4
6. Installation.....	5
Door Station.....	5
Indoor Phone.....	6
7. Operation.....	7
8. Trouble Shooting.....	8
9. Specifications.....	8

Any question towards our product,
please contact customer service center directly.

— After-sale service consultation procedure —

- ◆ Describe product name.
- ◆ Describe product model.
- ◆ Describe the trouble.
- ◆ Leave your Tel No. and e-mail address.

———— Statement ————

Please forgive us if we could not notify you timely
towards any alteration to our product model No.
or technical parameter.

If the user's manual is not consistent with the actual
operations due to technology upgrading, the
explanation right is reserved to our company.

8 Trouble Shooting

Symptom	Points to check
<ul style="list-style-type: none"> The power indicator of indoor phone is off after power up. 	Check the power supply wire connection.
<ul style="list-style-type: none"> Door station constantly beeps. 	Check the connection between the door station and the master indoor phone.
<ul style="list-style-type: none"> The power indicator of Sub. Indoor phone is on, but it doesn't work. 	
<ul style="list-style-type: none"> Door not unlocking. 	<ol style="list-style-type: none"> Check the diode is wired correctly Check if the connection between lock and door station is correct.

9 Specifications

Master Indoor Phone	
Model	7010K / 7130K
Screen	5" TFT / 7" TFT
Resolution	320*324 / 480*324
Operating voltage	DC 24V
Operating current	500mA
Standby current	100mA
Temperature	-10°C ~ +55°C
Humidity	10% ~ 95%

Subsidiary Indoor Phone	
Model	7010P / 7130P
Screen	5" TFT / 7" TFT
Resolution	320*324 / 480*324
Operating voltage	DC 24V
Operating current	350mA
Standby current	100mA
Temperature	-10°C ~ +55°C
Humidity	10% ~ 95%







Door Station	
Model	7S40 / 7S60
Operating voltage	DC 14~18V
Operating current	300mA
Standby current	30mA
Temperature	-40°C ~ +70°C
Humidity	10% ~ 95%
Camera	Color CCD, PAL system Visible angle: 90° Light source: White light LED Min. Illumination: 0.1 Lux.

1 System Functions

The basic function of this Intercom system is to provide audio and video communication between the external front door station and internal indoor phones.

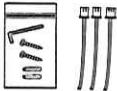
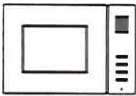
- The system can support up to four internal indoor phones and two external door stations.
- Internal audio communication between the indoor phones is possible via the intercommunication button on the indoor phone.
- There are two options to connect the lock, one is from external door station, another is from master indoor phone.
- An optional exit button can be fitted to the master indoor phone to provide unlocking of the door.

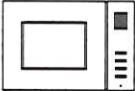
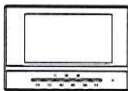
2 Components

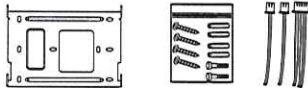
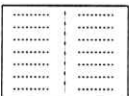
Door station			Master indoor phone	
7S40 	7S60 	Accessories 	7010K 	7130K 
Subsidiary (Abbreviated for "Sub.") indoor phone				
7010P 		7130P 		
Other fittings				
<input type="checkbox"/> Power supply 	<input type="checkbox"/> Indoor phone accessories 		<input type="checkbox"/> User manual 	

[Note] The power supply varies in different countries, please check with us before ordering.

3 Product Appearance

Door Station

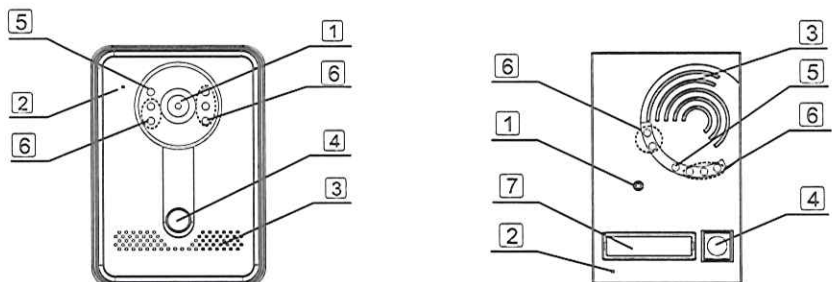

- 1 Camera 2 Microphone 3 Speaker 4 Call button
- 5 Sensitive LED 6 White light LED 7 Name plate

Indoor Phone

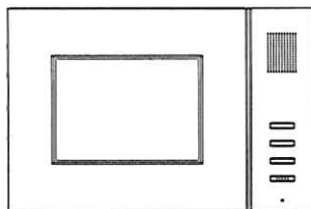

- ☆ Status indicator
- ⏻ Power indicator
- ⓧ Busy indicator
- ⓧ Mute indicator

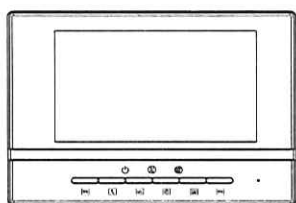

- ☆ Buttons
- ☎ Talk button
- 📺 Monitor button
- 🔑 Unlock button
- 🗣 Intercommunication button
- ⓧ Mute button

- ☆ Adjustment
- ☀️ Brightness adjustment
- Contrast adjustment
- 🔊 Ring volume adjustment
- ☎ Talk volume adjustment

7 Operation

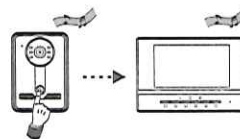

■ Call

1. When a visitor presses the call button on the door station, the indoor phone rings, and the screen shows the visitor's image.
2. If there is no answer, the system will automatically reset to standby mode after 30 seconds.

[Note] In two door stations system, if one of door stations is busy, the other door station's indicator will flash after the call button is pressed.

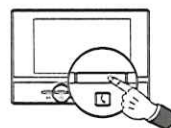

■ Talk

1. Press ☎ button on the indoor phone to answer the call.
2. While talking, press ☎ button again to end the talk (or press call button on the door station).

[Note] Conversation will time out after 120 seconds.

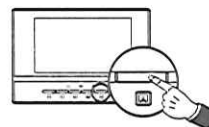

■ Monitor

1. In standby mode, press 📺 button on the indoor phone to view activity at the door station.
2. If there are two door stations fitted, to view at the different entrances.



3. In monitor mode, press ☎ button allows you to talk to the visitor.
- [Note] Monitoring the door station automatically ends after 30 seconds. If someone calls from the door station, monitoring ends and the indoor phone will chime.

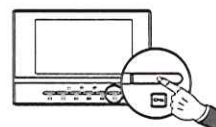

■ Unlock

Whilst ringing, talking or monitoring the door, press 🔑 button on the indoor phone to open the door.



■ Mute setting

Indoor phone 7010: Adjust the 🔊 Adjustment to the lowest, the ring will turn off, and the ⓧ indicator is on.

Indoor phone 7130: Press ⓧ button to mute ringing. When the ring is OFF, the ⓧ indicator is on.

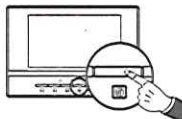

■ Intercom between indoor phone

1. In standby mode, press 🗣 button on any of the indoor phones, the other indoor phones will ring.
2. Press ☎ button on the ringing indoor phone to talk. Any other indoor phones will stop ringing;

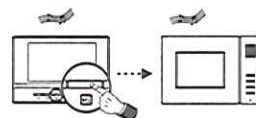

[Note] 1. There is no image during the intercom between indoor phones.
 2. While ringing other indoor phones, press 🗣 button to end the call.
 3. In intercom mode, if someone calls from door station, it will end this intercom immediately.

Indoor Phone

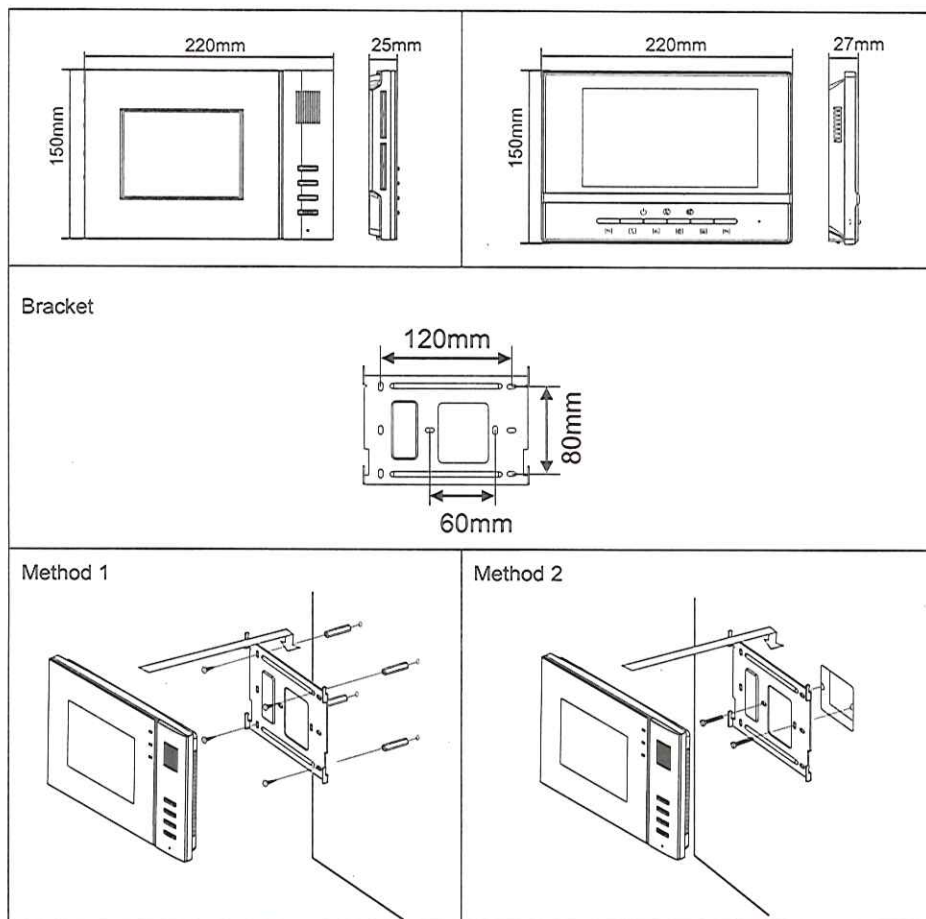

△ Installation Tips

1. Don't install the indoor phone in wet areas.
2. Keep away from direct heat.
3. Don't clean the indoor phone with wet towels or harsh cleaning agents.
4. Do not disassemble the product. If failure occurs contact your service provider.

4 System Diagram

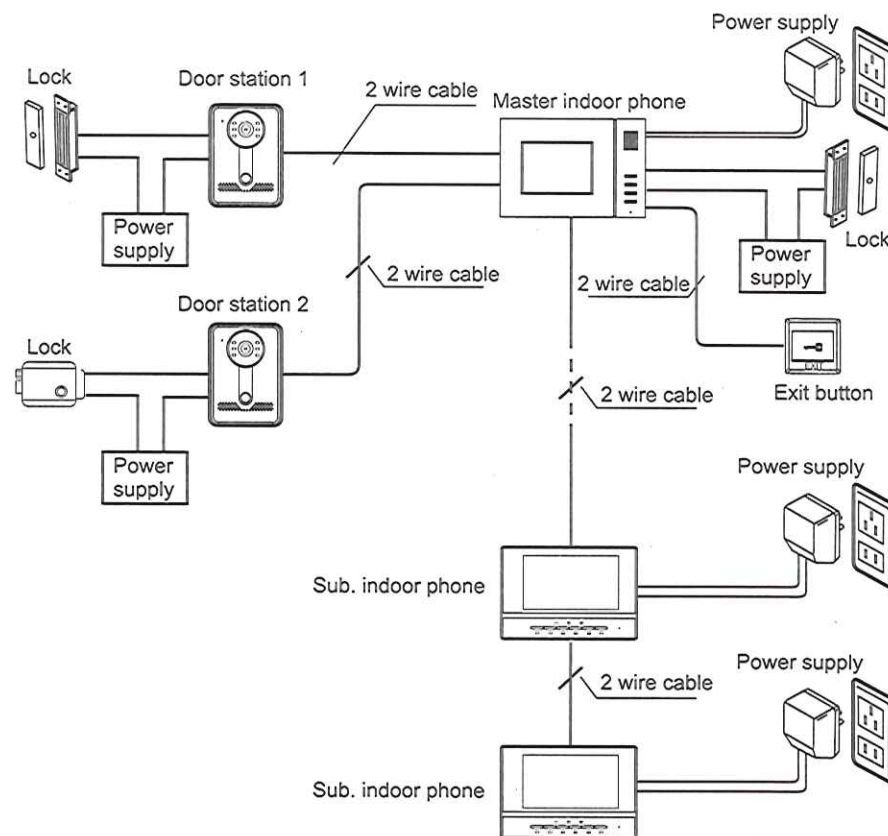

Wiring Recommendations:

1. Wiring distance between the front door station and the last indoor phone should be less than 200m.
2. Single wire resistance between the front door station and the master indoor phone should be less than 10Ω.
3. Recommended Cable is polyethylene Double insulated 1.2mm.

5 Wiring Diagram

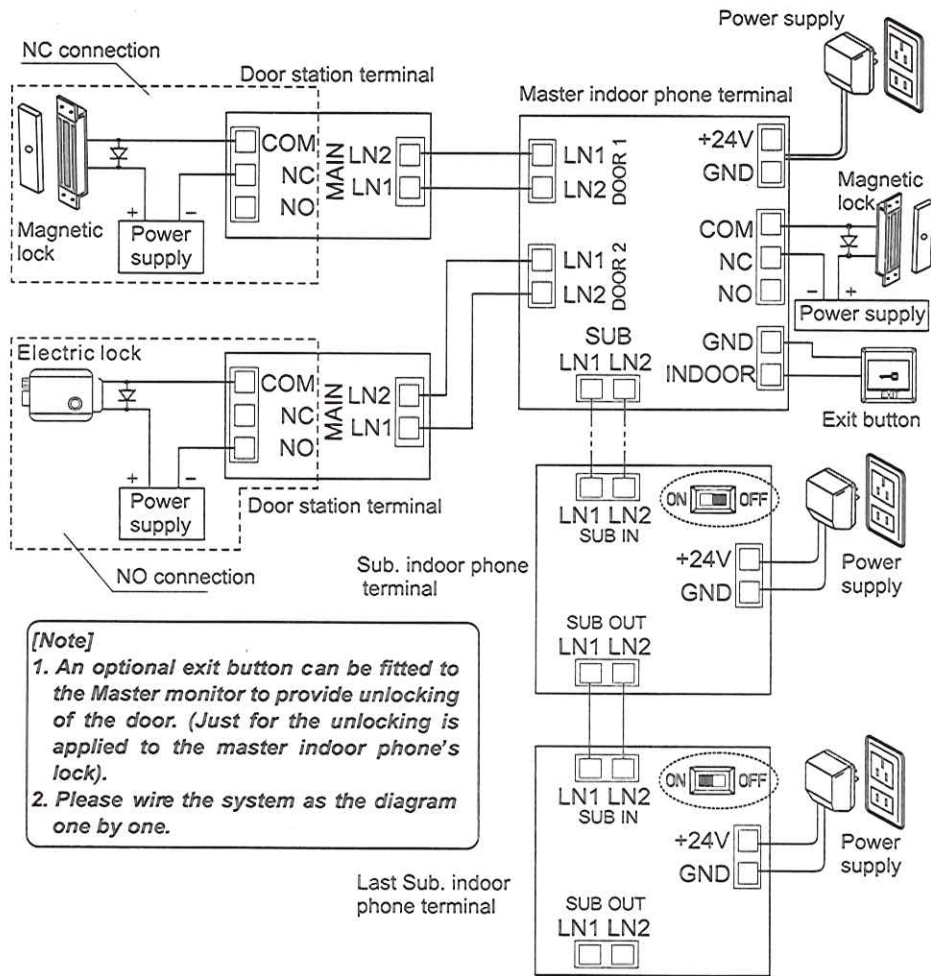

Switches on the back of the indoor phone.

Unlock time setting:

(Only for the MASTER indoor phone)

Unlock time: 1s

Unlock time: 5s

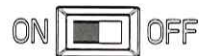
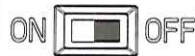

Video matching:

(Only for the Sub. indoor phone)

The last indoor phone's switch should be "ON", and the other Sub. indoor phones' switch should be "OFF".

6 Installation

Door Station

Size: 140×100×43 mm

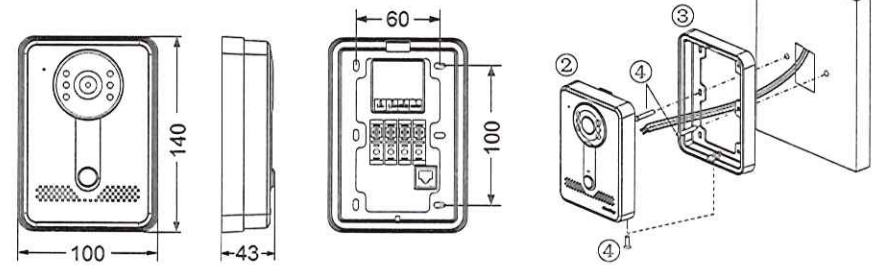

① Door/Wall ② Door station front
③ Door station Bracket ④ Screw

Size: 118×76×29 mm

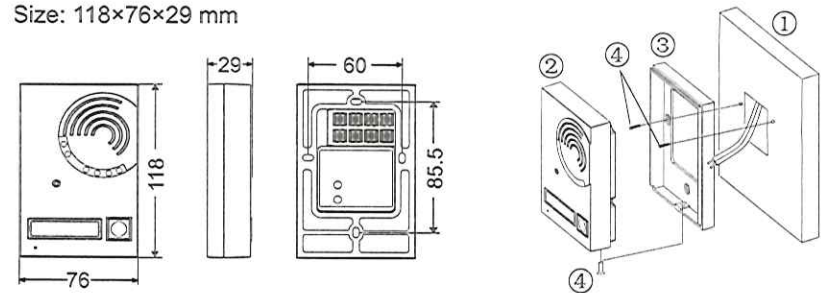

① Door/Wall ② Door station front
③ Door station Bracket ④ Screw

△ Installation tips:

1. Don't install door station near humid, stove, and dusty condition.
2. There are waterproof silicone sheets attached to the reverse of the door station, please install the door station to a smooth wall to guarantee the waterproof function.
3. We suggest the installation height of 1400mm. Also consider other factors such as the angle of view and handicapped access.